



Officina Meccanica

**PIETRO RAMELLA & C. s.a.s**

Carding sets and carding machines producers since 1947

Via S.M. di Campagnate, 14

13900 - BIELLA (BI) - ITALY

tel. +39-015-401755 fax +39-015-8492807

www.ramellapietro.com e-mail ramella@ramellapietro.com

## **MODEL AS 200 w.w. 3000 mm**

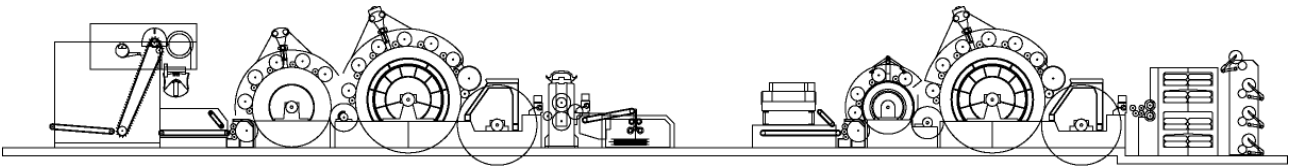

### **Technical description and machine composition :**

- Automatic hopper feeder
- 1<sup>st</sup> inlet unit
- Breast
- 1<sup>st</sup> carding group
- Cleaner unit (peralta)
- Underground conveyor
- 2<sup>nd</sup> inlet unit and little card
- 2<sup>nd</sup> carding group
- Double tape condenser with multiple laces and traversing creel

## AUTOMATIC HOPPER FEEDER

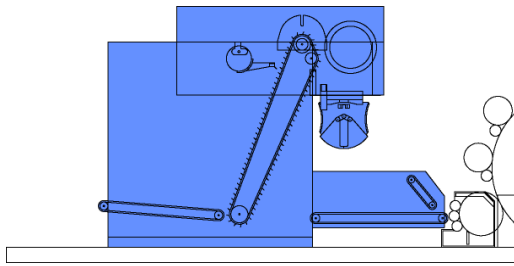

The automatic hopper feeder introduces the raw material in the carding machine in a regular and constant way.

The automatic hopper feeder is provided with 4 tables:

- Pinned table with outer mantle in PVC, slats of multi-layer plywood and pins of tempered steel.
- Mixing table, feeding table and press mixture table with outer mantle in PVC and slats of multi-layer plywood.

The pinned table unload is done by a rotatory comb with teeth in PVC. It is studied to discharge completely the pinned table without leaving remaining material on it.

With very easy adjustments of the dosing table, it is possible to increase or decrease the charging speed to do the weighing in the exact time limit also changing the material or the outlet speed.

A blend pusher plate, placed on the feeding table, makes compact and uniform the material discharged by the basket.

The balance basket, suitable to contain long, bulky and light fibres, is assembled on special hardened fulcrums. The basket has a special shape and the opening is done by a pneumatic cylinder.

The balance basket is very precise and the weighing is controlled by suited devices that stop the machine in case of wrong weighing.

The basket filling is done by a two-speed engine with inverter that drives the pinned table.

After the weighing two plates, pneumatically controlled, cover the basket preventing the accidental material fall.

It is possible to change the quantity of material loaded bringing the dosing comb near or moving it away from the pinned table.

The combs (dosing and unloading) are driven by a single gear-motor.

All these devices are deliberately studied and are guaranteed by a long application in the carding field.

## 1<sup>st</sup> INLET UNIT

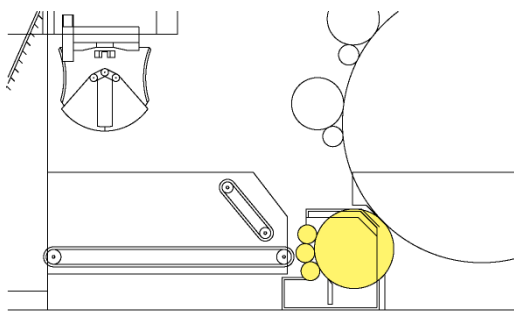

composed of :

N. 1	Upper taker-in roller	∅ 100 mm	Rigid card clothing
N. 1	Under taker-in roller	∅ 100 mm	Rigid card clothing
N. 1	Cleaner roller	∅ 100 mm	Rigid card clothing
N. 1	Opener roller	∅ 420 mm	Rigid card clothing

The inlet unit introduces the material in the breast in a regular way, avoiding, through the safety devices, the foreign bodies entry into the process.

All rollers are wired with rigid card clothing saw tooth type.

The opener roller rotates toward the lower and it's provided with a knife with a nails puller knife that eliminates the foreign bodies among the fibres.

The opener roller is provided with a first class safety device that stops the machine in case of foreign bodies get into the processing.

The inlet unit rollers are controlled by a speed variator that can be easily regulated on the main electric panel.

## BREAST

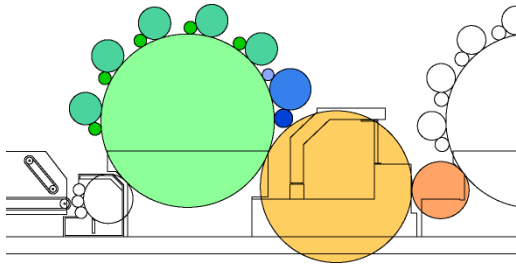

composed of :

N. 1	Drum	∅ 1500 mm	Rigid card clothing
N. 5	Worker rollers	∅ 270 mm	Rigid card clothing
N. 5	Cleaner rollers	∅ 100 mm	Rigid card clothing
N. 1	Conveyor roller	∅ 530 mm	Flexible card clothing

The breast opens the fibres entering in process in tangled way and prepares them to the following passage. The conveyor roller connects the breast to the first unit.

The rollers are constructed in steel and wired with rigid card clothing saw tooth type. This unit is clothed with rough card clothing to give a first opening to the material.

The frame is made of double steel sheet .

Crescents are manufactured in a single piece of cast iron, they are turned externally for the right fitting with covers.

## 1<sup>st</sup> CARDING GROUP

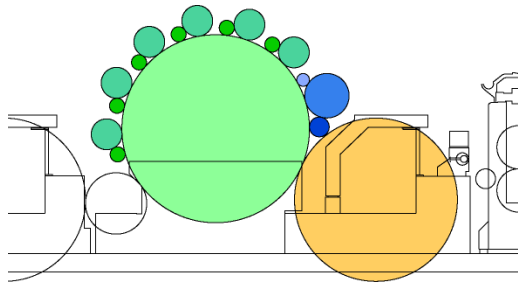

composed of :

N. 1	Drum	∅ 2000 mm	Flexible card clothing
N. 6	Worker rollers	∅ 250 mm	Flexible card clothing
N. 6	Cleaner rollers	∅ 100 mm	Rigid card clothing
N. 1	Upper fancy roller	∅ 90 mm	Rigid card clothing
N. 1	Fancy roller	∅ 400 mm	Flexible card clothing
N. 1	Under fancy roller	∅ 140 mm	Flexible card clothing
N. 1	Comber roller	∅ 1500 mm	Flexible card clothing

The first unit improves the fibres parallelizing partially done by the breast.  
The fancy roller permits a better material removal by the doffer roller.

The fancy roller is clothed with a flexible card clothing placed on a web with rubber bottom.  
All other cylinders are wired with rigid card clothing saw tooth type.  
The fancy roller and all worker rollers are made of light aluminum alloy.  
All other cylinders are made of steel.

## FLY-COMBS AND CLEANER UNIT (PERALTA)

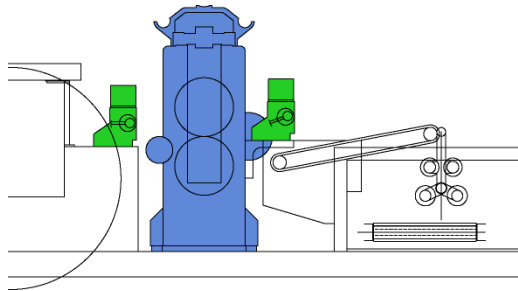

composed of :

N. 2	Cleaner roller	∅ 350 mm	
N. 1	Standing gauze roller	∅ 160 mm	
N. 1	Doffer roller	∅ 250 mm	Flexible card clothing
N. 2	Fly-comb		

The fly comb detaches the web from doffer roller, it moves at high speed with a 40 mm oscillation.  
The peralta unit pulverizes the web impurities for an easy removal by the cleaner rollers.

Cleaner rollers are manufactured in centrifuged and hardened cast iron with a superficial hardness of 500 Brinnell.

The upper cleaner roller is pressed downward by two hydraulic cylinders for a better web compression.  
The doffer roller removes the web from the cleaner rollers and after it's unloaded by the second fly-comb.  
The lateral frame shape has been studied to obtain a perfect contact between the two rollers.

## UNDERGROUND CONVEYOR

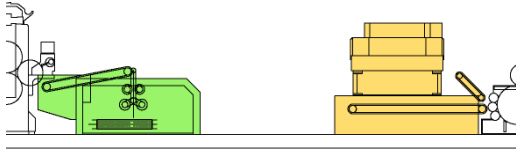

The conveyor consists of three parts that serve respectively for:

- gathering the web outgoing from the peralta unit and putting it as laid layers to make a ribbon.
- transporting the ribbon in a underground pipe to the following part
- distributing the ribbon on the feeding table of the following carding group

A speed variator permits to control the web tension between peralta and belt conveyor.

A second speed variator permits to control the ribbon width on the feeding table.

A device controls the ribbon centring on the feeding table.

The conveyor is provided with a photoelectric cell that stops the machine and gives a sound signal in case of web breakage.

## 2<sup>nd</sup> INLET UNIT AND LITTLE CARD

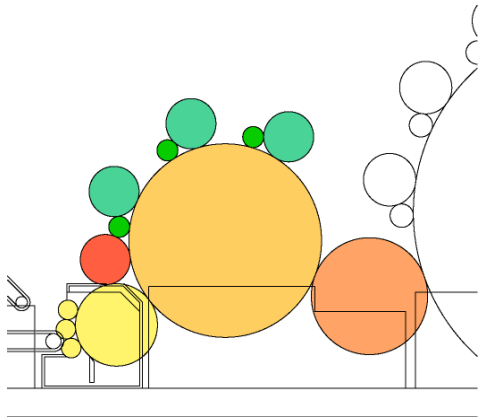

composed of :

N. 1	Upper roller	∅ 100 mm	Rigid card clothing
N. 1	Lower roller	∅ 100 mm	Rigid card clothing
N. 1	Cleaner roller	∅ 100 mm	Rigid card clothing
N. 1	Opener roller	∅ 420 mm	Rigid card clothing
N. 1	Drum	∅ 1000 mm	Rigid card clothing
N. 1	Knot-breaker roller	∅ 262 mm	Rigid card clothing
N. 3	Worker roller	∅ 262 mm	Rigid card clothing
N. 3	Cleaner roller	∅ 110 mm	Rigid card clothing
N. 1	Conveyor roller	∅ 600 mm	Flexible card clothing

The second inlet unit has similar functions of the first one.

The opener roller rotates upward and on it there is a carding group (worker roller and cleaner roller) that regularizes the fibres before the second carding group processing.

## 2<sup>nd</sup> CARDING GROUP

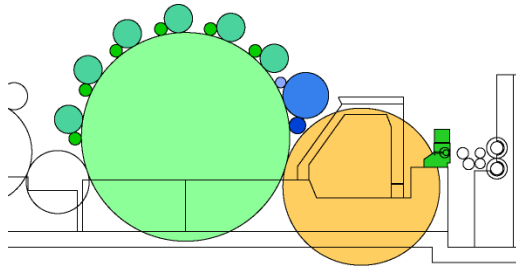

composed of :

N. 1	Drum	∅ 2000 mm	Flexible card clothing
N. 6	Worker rollers	∅ 250 mm	Flexible card clothing
N. 6	Cleaner rollers	∅ 100 mm	Rigid card clothing
N. 1	Upper fancy roller	∅ 90 mm	Rigid card clothing
N. 1	Fancy roller	∅ 400 mm	Flexible card clothing
N. 1	Under fancy roller	∅ 140 mm	Flexible card clothing
N. 1	Comber roller	∅ 1500 mm	Flexible card clothing
N. 1	Fly-comb		
N. 1	Conveyor belt		
N. 1	Conveyor roller	∅ 284 mm	Flexible card clothing

The group has the same characteristics of the first carding group.

## TAPE CONDENSER UNIT WITH MULTIPLE LACES AND TRAVERSING CREEL

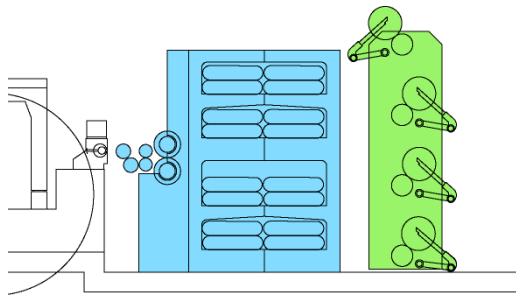

composed of :

N. 2	Grooved cylinders	∅ 201 mm
N. 2	Sleek driving laces cylinders	∅ 100 mm
N. 4	Grooved driving cylinders	∅ 100 mm
N. 4	Stretching laces cylinders	∅ 100 mm
N. 16	Rubber sleeves with n. 2 columns eccentrics.	

The tape condenser is composed by two parts:

- the first part divides the web outgoing from the last doffer roller
- the second part give consistence to the slubbings through the movement of the rubber sleeves

Through the traversing creel the slubbings are rolled up the roving rolls.

The slubbings number depends on the worked material and on the fibre metric count to be obtained.

The web is divided in slubbings by multiple laces.

The tape condenser has a double series of rubber sleeves to obtain a better condensation and an higher exit speed.

The rubber sleeves tension is done by 2 rollers.

On each rubber sleeves couple three cylinders permit to regulate the rubber sleeves distance.

The roving rolls number on the traversing creel depends on the worked material, the slubbings number and the spinning frame utilized.

A speed variator regulate the tension between the rubber sleeves and the traversing creel.

The mechanisms that translate the traversing creel are projected to obtain a fast motion inversion and then an uniform material distribution on the roving rolls.

## TECHNICAL DETAILS

The machine drives are divided in 2 parts:

- The first one drives the drums.
- The second part drives the inlet units, the comber rollers, the conveyor roller and the condenser unit.

The first part is composed of 1 motor with variable speed that drives with specific gear transmission the breast the 1<sup>st</sup> drum and the 2<sup>nd</sup> drum.

The second part is composed of a drive shaft driven by a variable speed motor. On this shaft are inserted the gear-cases with conical helical gears in oil bath driving the different parts (inlet units, combers, cleaner units and condenser).

The variable speed motors can be easily controlled by the main electric panel.

All rotary parts are assembled on first-class ball bearing.

Main cylinders and doffers are made in steel sheet heat treated into an electric furnace.

## ELECTRIC PANEL

The panel is provided with user-friendly devices to control the motors speed and the total production.

An electrical stabilizer provide the right power supply to all electrical parts.

An electronic scaler with pre-selector allows to state an acoustic signal to remove the quills and another device displays the total production.

The panel is provided with acoustic alarm that rings in case of :

- automatic feeder wrong weighing
- signal of the conveyor roller photoelectric cell
- signal of the inlet unit safety device.

## FRAME

The frame is fully manufactured in our factory in steel sheet and it is heat treated in special electric furnace. It is made of double steel sheet with internal strengthening that completely eliminates the vibrations.

Crescents are manufactured in a single piece of cast iron, they are turned externally for the right fitting with covers.

## **PROTECTION SYSTEMS AND QUALITY CERTIFICATION**

Both sides of the machine are completely protected by security doors according to the current rules. The lock device doesn't allow open the lateral protections while the machine is running. This will be deactivated only when the machine is completely stopped and if all protection doors are closed.

Covers protect the upper side of the machine: they are in steel sheets with aluminum rims and they are provided with electric lift device and automatic blockage system. The blockage system is deactivated only when the carding machine is completely stopped.

The machine is marked C.E. and follows UNI EN ISO 9002 rules.